

---

# Instruction Manual

## Differential Pressure Transducer Model P92

---



halstrup-walcher GmbH

Stegener Straße 10  
D-79199 Kirchzarten  
Germany

Phone: +49 (0) 76 61/39 63-0  
Fax: +49 (0) 76 61/39 63-99

E-Mail: [info@halstrup-walcher.com](mailto:info@halstrup-walcher.com)  
Internet: [www.halstrup-walcher.com](http://www.halstrup-walcher.com)

## Table of Contents

|   |    |
|---|----|
| 1 Safety precautions .....  | 5  |
| 1.1 Appropriate use.....  | 5  |
| 1.2 Shipping, assembly, electrical connections and start-up ..... | 5  |
| 1.3 Troubleshooting, maintenance, repairs, disposal .....         | 5  |
| 1.4 Symbols .....   | 6  |
| 2 Instrument description .....                                    | 7  |
| 3 Start-up.....   | 7  |
| 3.1 Features.....   | 7  |
| 3.2 Overload capacity .....                                       | 7  |
| 3.3 Analog outputs .....  | 8  |
| 3.4 Instrument connections: .....                                 | 8  |
| 4 Mounting.....   | 10 |
| 5 External zero-point correction (optional).....                  | 11 |
| 6 Configuring the analog output .....                             | 11 |
| 7 Modifying creep suppression .....                               | 13 |
| 8 Description of the RS 232C serial interface (optional) .....    | 13 |
| 8.1 Instrument connections .....                                  | 13 |
| 8.2 Command input.....  | 14 |
| 8.3 Brief overview of commands .....                              | 14 |
| 8.4 Alphabetical list of commands.....                            | 15 |
| 9 Design of the Profibus DP (optional) .....                      | 18 |
| 9.1 Features.....   | 18 |
| 9.2 Connecting the supply voltage and setting the address.....    | 19 |
| 9.3 Modules .....   | 20 |
| 9.3.1 Status .....  | 20 |
| 9.3.2 Differential pressure (I16 0...100.00%).....                | 20 |
| 9.3.3 Differential pressure (FP).....                             | 20 |

|  |    |
|--|----|
| 9.3.4 Flow (root-extracted differential pressure FP) ..... | 21 |
| 9.3.5 Control .....  | 21 |
| 9.4 Setting parameters .....                               | 21 |
| 9.4.1 Creep suppression .....                              | 21 |
| 9.4.2 Output units .....                                   | 22 |
| 9.4.3 Measurement range spread .....                       | 22 |
| 9.4.4 Output value .....                                   | 22 |
| 9.4.5 Zeroing interval .....                               | 22 |
| 9.4.6 Positive (negative) threshold pressure .....         | 22 |
| 9.4.7 Time constant .....                                  | 22 |
| 10 Technical data .....                                    | 23 |
| 11 Dimension drawing .....                                 | 25 |

## Purpose of instruction manual

This instruction manual describes the features of the P 92 differential pressure transducer and provides guidelines for its use.

Improper use of this instrument or failure to follow these instructions may cause injury or equipment damage. Every person who uses the device must therefore read the manual and understand the possible risks. The instruction manual, and in particular the safety precautions contained therein, must be followed carefully. **Contact the manufacturer if you do not understand any part of this instruction manual.**

Handle this manual with care:

- It must be readily available throughout the lifecycle of the instrument.
- It must be provided to any individuals who assume responsibility for operating the instrument at a later date.
- It must include any supplementary materials provided by the manufacturer.

The manufacturer reserves the right to continue developing this instrument model without documenting such development in each individual case. The manufacturer will be happy to determine whether this manual is up-to-date.

## Conformity

This device is state of the art. It complies with the legal requirements of EC directives. This is shown by the CE mark.



© 2005

The manufacturer owns the copyright to this instruction manual. It contains technical data, instructions and drawings detailing the device's features and how to use it. It must not be copied either wholly or in part or made available to third parties.

# 1 Safety precautions

## 1.1 Appropriate use

In addition to differential pressure data, the P 92 differential pressure transducer also records positive and negative overpressures.

Always observe the operating requirements—particularly the permissible supply voltage—indicated on the rating plate and in the "Technical data" section of this manual.

The instrument may only be handled as indicated in this manual. Modifications to the instrument are prohibited. The manufacturer is not liable for damages caused by improper use or failure to follow these instructions. Violations of this type render all warranty claims null and void.

## 1.2 Shipping, assembly, electrical connections and start-up

Do not close the pressure inlets during shipping. Changes in barometric pressure may damage devices with low measuring ranges.

Assembly and the electrical connections should only be handled by professionals. They should be given proper training and be authorized by the operator of the facility.

The instrument may only be operated by appropriately trained individuals who have been authorized by the operator of the facility.

Do not carry out a function test with compressed or breathable air. This would damage instruments with low measuring ranges.

Measurement errors may occur if the instrument is not kept protected from sunlight.

Specific safety precautions are given in individual sections of this manual.

## 1.3 Troubleshooting, maintenance, repairs, disposal

The individual responsible for the electrical connections must be notified immediately if the instrument is damaged.

This individual must take the instrument out of service until the error has been corrected and ensure that it cannot be used unintentionally.

### **Always unplug the supply voltage before opening the instrument!**

This instrument requires no maintenance.

Only the manufacturer may perform repairs that require the housing to be opened.

The electronic components of the instrument contain environmentally hazardous materials and materials that can be reused. The instrument must therefore be sent to

a recycling plant when you no longer wish to use it. The environment codes of your particular country must be complied with.

#### 1.4 Symbols

The symbols given below are used throughout this manual to indicate instances when improper operation could result in the following hazards:



**WARNING!** This warns you of a potential hazard that could lead to bodily injury up to and including death if the corresponding instructions are not followed.



**WARNING:** This warns you of a potential hazard that could lead to significant property damage if corresponding instructions are not followed.



**INFORMATION** This indicates that the corresponding information is important for operating the instrument properly.

## 2 Instrument description

In addition to differential pressure data, the P 92 differential pressure transducer also records positive and negative overpressures. Process variables are converted into standardized signals. The instrument utilizes an inductive measurement principle for determining the deflection of a CuBe membrane spring; it then uses the results of these measurements to determine the pressure. The use of a microprocessor provides for a high level of precision and a great deal of flexibility. This differential pressure transducer is especially suitable for highly sophisticated applications such as pressure monitoring in clean rooms, laboratories, pharmaceutical facilities and operating rooms, and for special mechanical engineering applications.

The P92 pressure transducer is a pneumatic, electronic sensor for measuring overpressures, vacuum pressures and differential pressures. At its heart is a pressure measurement capsule with a beryllium bronze membrane spring, which is displaced by the pressure difference between the two chambers of the measurement capsule. Inductive displacement transducers measure membrane deflection without contacting the membrane. The instrument has no frictional parts or parts subject to mechanical wear.

The transducer is EMC-optimized and has a power supply input filter (for models with a metal housing).

## 3 Start-up

### 3.1 Features

The instrument automatically performs three zero-point calibrations within the first hour after connection to the power supply (i.e., while the sensor is warming up); this process is then carried out again roughly once an hour. It takes at least 1 s for the instrument to run through this cycle and set the zero-point, during which time it cannot take any measurements; output consists of the most recently measured value. Automatic zero-point calibration allows the instrument to compensate for temperature drift and positional error of the sensor. An external control input may also be used to correct the zero point (optional).

If the pressure applied at one of the inputs is larger than a permissible threshold parameter, a valve cuts off the source of the pressure from the pressure measurement capsule, thereby preventing damage to the latter. The most recently measured value is read out at the sensor output.

### 3.2 Overload capacity

Under zero-current conditions, the sensor is protected from overpressures of up to 200 kPa at both ports. During operation, the sensor provides overpressure protection at both ports of up to 200 times the limit of the measurement range, but no more than 600 kPa.

### 3.3 Analog outputs

The instrument's output signal is either root-extracted or proportional to the pressure (rotary switch allow the operator to toggle between these two options). Output may take the form of voltage (0...10 V) or current (0 / 4...20 mA); the latter can be configured to either 0...20 mA or 4...20 mA with the aid of a plug-in shorting jumper. The operator may also set eight different time constants (i.e., sensor response times). An additional jumper allows the operator to reduce the measurement range by half, i.e., at half the nominal pressure, the output will read out 10 V / 20 mA.

If the measured value is small, a root-extracted output signal may result in large deflection errors. Creep suppression makes it possible to suppress the output signal on or near the zero point. The operator can use a shorting jumper to set creep suppression to 3%, 4%, 5% or 6% of the root-extracted limit of the measurement range.

### 3.4 Instrument connections:

Plastic or metal housing with 24 V DC/AC power supply:

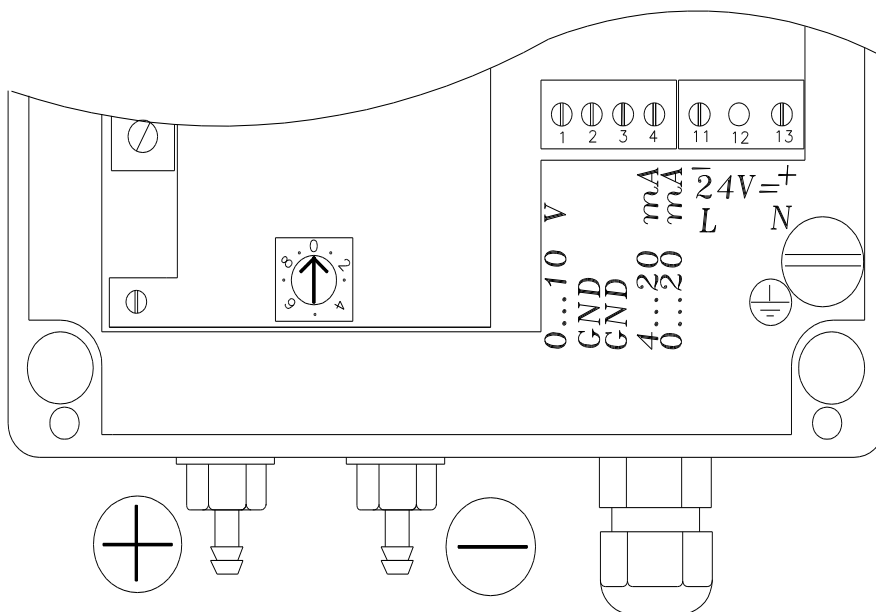

- Fig. 1 -



**The ground wire must be threaded onto the ground screw for units with a metal housing.**

Metal housing with 230 V / 115 V AC power supply:

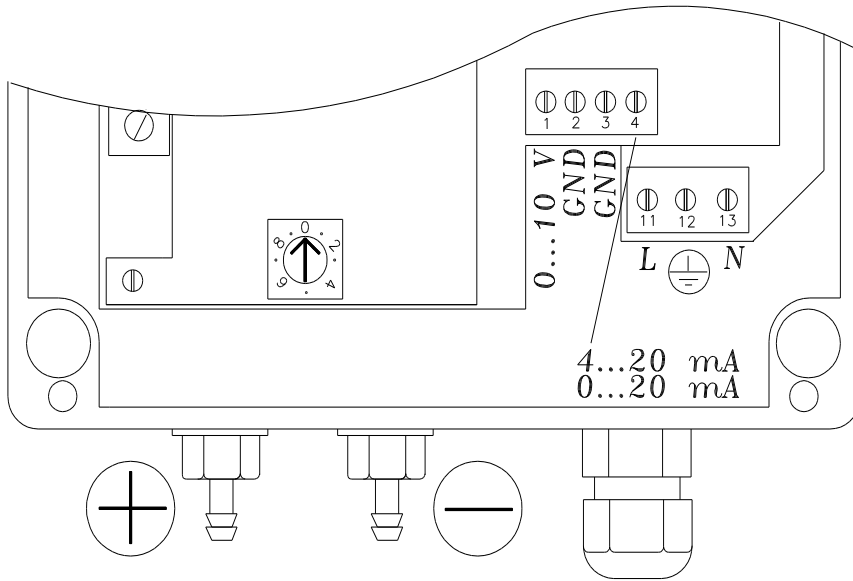

- Fig. 2 -



Observe the required supply voltage (see rating plate).

Display-connector

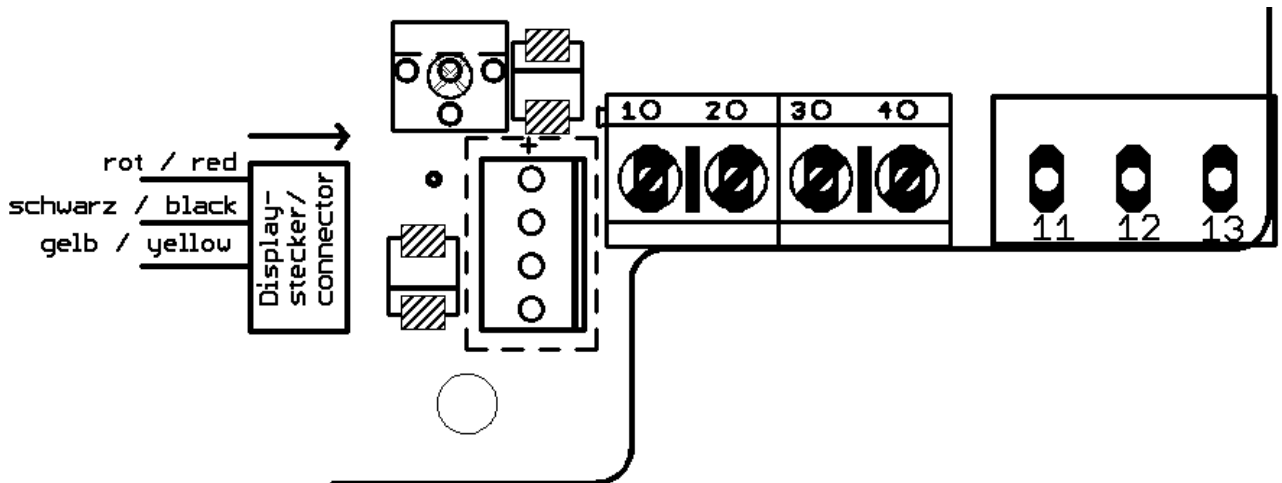

## 4 Mounting

Although the P92 pressure transducer is highly robust, it is nevertheless a precision instrument and should be handled with care. Avoid mounting the P92 in the direct vicinity of any sources of heat or radiation. Ideally, the instrument should be mounted vertically (pressure and vacuum ports should be pointing down) and on a wall not subject to vibration.

The supply voltage should be connected at the terminal (11...13) indicated in the connection diagram on the housing cover.

Output signals are available on the signal terminal (1...4) as follows:

|                 |   |               |
|-----------------|---|---------------|
| Voltage output: | 1 | 0...10 V      |
|                 | 2 | signal ground |
| Current output: | 4 | 0 / 4...20 mA |
|                 | 3 | signal ground |

## 5 External zero-point correction (optional)

Connecting the round, 7-pin plug:

pin 1: earth

pin 3: floating contact or a level of +5 V...+24 V

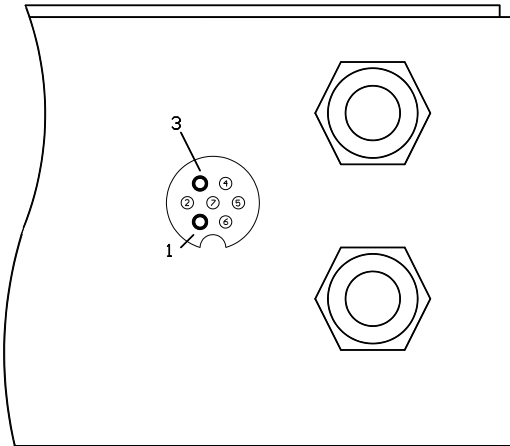

- Fig. 3 -

There are two operating modes for external zero-point correction:

1.) The contact is open (high level):

The zero point is set by briefly closing the contact, i.e., by generating a brief (>50 ms) low level; the zero-point setting cycle remains active, however.

2.) The contact is closed (low level):

The zero point can only be set by briefly opening the contact, i.e., by generating a brief (>50 ms) high level; the zero-point setting cycle is suppressed.

## 6 Configuring the analog output

The S1 switch can be used to set the time constant and mode of sensor operation (see table below):

| Switch position | Time constant | Output signal | Switch position | Time constant | Output signal  |
|-----------------|---------------|---------------|-----------------|---------------|----------------|
| 0               | none          | linear        | 8               | none          | root-extracted |
| 1               | 1 s           | linear        | 9               | 1 s           | root-extracted |
| 2               | 2.5 s         | linear        | A               | 2.5 s         | root-extracted |
| 3               | 5 s           | linear        | B               | 5 s           | root-extracted |
| 4               | 10 s          | linear        | C               | 10 s          | root-extracted |
| 5               | 20 s          | linear        | D               | 20 s          | root-extracted |
| 6               | 30 s          | linear        | E               | 30 s          | root-extracted |
| 7               | 40 s          | linear        | F               | 40 s          | root-extracted |

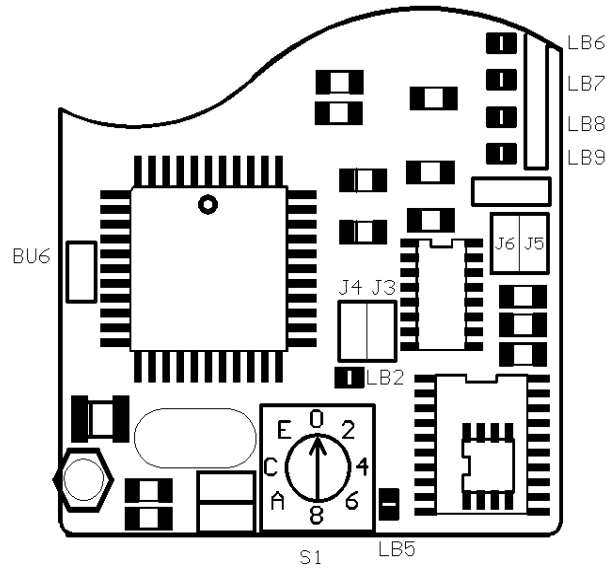

- Fig. 4 -

The J5 shorting jumper can be used to configure the current output to between 0...20 mA and 4...20 mA.

**J5:                      Current output:**

|        |           |
|--------|-----------|
| open   | 4...20 mA |
| closed | 0...20 mA |



If the current output is configured to 4...20mA, please note, that the voltage output reads out 2...10 V instead of 0...10 V.

The J6 shorting jumper can be used to reduce the measurement range by half.

**J6:                      Measurement range:**

|        |                        |
|--------|------------------------|
| open   | full measurement range |
| closed | half measurement range |



The sensor element remains unchanged for both ranges, which means that halving the measurement range merely spreads the measured values. For small measurement ranges and in some special cases it is worth evaluating whether halving the measurement range is expedient.

## 7 Modifying creep suppression

The J3 and J4 shorting jumpers can be used to set creep suppression (see table below):

| <b>J4</b>     | <b>J3</b>     | <b>Creep suppression</b> |
|---------------|---------------|--------------------------|
| <i>open</i>   | <i>open</i>   | 3 %                      |
| <i>open</i>   | <i>closed</i> | 4 %                      |
| <i>closed</i> | <i>open</i>   | 5 %                      |
| <i>closed</i> | <i>closed</i> | 6 %                      |

## 8 Description of the RS 232C serial interface (optional)

### 8.1 Instrument connections

|                             |                          |
|-----------------------------|--------------------------|
| <i>communication method</i> | <i>full duplex</i>       |
| <i>synchronization</i>      | <i>Start/stop system</i> |
| <i>transfer code</i>        | <i>ASCII</i>             |
| <i>data bit</i>             | <i>8</i>                 |
| <i>stop bit</i>             | <i>1</i>                 |
| <i>parity check</i>         | <i>none</i>              |
| <i>baud rate</i>            | <i>9600 Bd</i>           |

| <b>Pin no.</b> | <b>Name of signal</b> | <b>Signal direction (from the P92)</b> |
|----------------|-----------------------|--|
| 1              | GND                   |  |
| 5              | SD (TXD)              | <i>output</i>                          |
| 7              | RD (RXD)              | <i>input</i>                           |

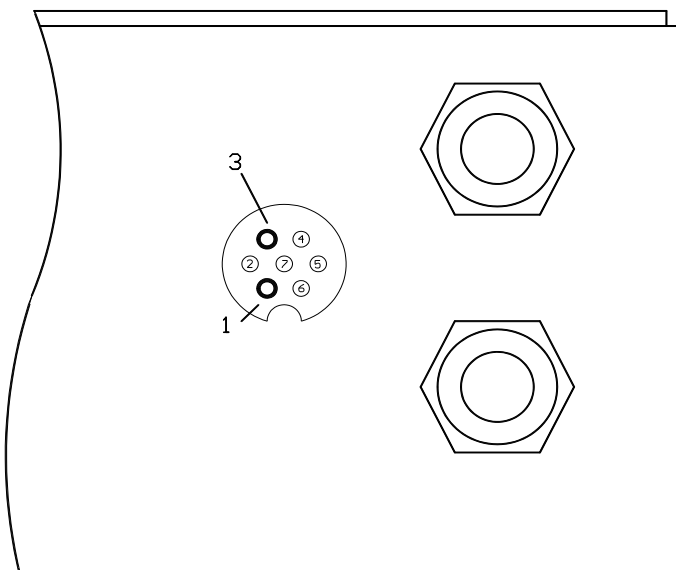

## 8.2 Command input

The P92 pressure transducer is ready to receive commands once the operating voltage has been switched on.

The computer sends a command to the P92 by first transmitting a command letter (capital or lower case are both possible) and then possibly one additional parameter (see list of commands). The command must conclude with the *CR* code (carriage return; *ODH*).

The P92 immediately returns all codes that it receives (full duplex).

After receiving a command, the P92 first transmits the *CRLF* (carriage return, line feed; *ODH OAH*) and an acknowledgement message or the required value (see list of commands). It then transmits *CRLF* and is then ready to receive another command.

## 8.3 Brief overview of commands

| Command | Description                             | Response:  |
|---------|---|--|
| D       | request for measured value              | measured value; format: thousandths of the measurement range                         |
| Z       | sets attenuation of pressure transducer | if parameters are correct: <i>O.K.</i><br>if parameters are incorrect: <i>SYNTAX</i> |
| N       | zero-point correction                   | correction successful: <i>O.K.</i><br>correction not possible: <i>ERROR</i>          |
| L       | linear mode of operation                | <i>O.K.</i>  |
| R       | root-extracted mode of operation        | <i>O.K.</i> if a $\pm$ pressure sensor:<br><i>SYNTAX</i>                             |
| K       | no zero-point correction cycle          | <i>O.K.</i>  |
| S       | zero-point correction cycle             | <i>O.K.</i>  |



### Please note:

An RS 232C or rotary switch may be used to set transducer parameters (attenuation, mode of operation, etc.). Parameters are backed up in an EEPROM; the most recently saved parameters are valid when the transducer resumes operation. If parameters are modified using an RS232C, the position of the rotary switch does not indicate the current transducer parameters. The rotary switch must be rotated before it can reflect the current parameters.

## 8.4 Alphabetical list of commands

**D:** requests pressure measurement value

This command is used to request a measured value from the P92 pressure transducer.

Output for sensors with **only pos. differential pressure (measurement range 0...Pa)** is given in thousandths of the measurement range.

### Example:

A 0...100 Pa sensor has a measured value of 78.0 Pa:

Input:

*D CR*

ASCII code:

*44H 0DH*

Acknowledgement:

*CRLF 780 CRLF*

*0DH 0AH 37H 38H 30H 0DH 0AH*

For sensors with **pos. and neg. differential pressures ( $\pm$  measurement ranges)**, the zero point of the digital display is 500. The pos. limit of the measurement range is 1000 and the neg. limit is 0.

### Example 1:

A  $\pm 100$  Pa sensor has a measured value of 0 Pa:

Input:

*D CR*

ASCII code:

*44H 0DH*

Acknowledgement:

*CRLF 500 CRLF*

*0DH 0AH 35H 30H 30H 0DH 0AH*

### Example 2:

A  $\pm 100$  Pa sensor has a measured value of +70.0 Pa:

Input:

*D CR*

### Example 3:

A  $\pm 50$  Pa sensor has a measured value of -35.0 Pa:

Input:

*D CR*

Acknowledgement:

*CRLF 150 CRLF*

|                                       |
|---------------------------------------|
| K: blocks zero-point correction cycle |
|---------------------------------------|

This command blocks periodic zero-point correction. This may be useful if the user would like to eliminate the risk of the sensor setting the zero point at precisely the moment when a measured value is needed. No new measured values are available for approx. 1s during the zero-point correction process. When in this mode, operators are advised to first initiate a zero-point calibration via the 'manual' *N* command and only then request the actual measured value.

Input:Acknowledgement:*K CR**CRLF O.K. CRLF*

ASCII code:

*4BH 0DH**0DH 0AH 4FH 2EH 4BH 2EH 0DH 0AH*

|                         |
|-------------------------|
| L: linear output signal |
|-------------------------|

The mode of sensor operation is linear, i.e., the output voltage, output current and output values read out over the interface are proportional to the pressure.

After this command is executed, it is acknowledged with an *O.K.*

Input:Acknowledgement:*L CR**CRLF O.K. CRLF*

ASCII code:

*4CH 0DH**0DH 0AH 4FH 2EH 4BH 2EH 0DH 0AH*

|                          |
|--------------------------|
| N: zero-point correction |
|--------------------------|

This command initiates calibration of the pressure transducer's zero point.

The instrument may not be able to run a zero-point correction, if, for instance, the sensor element has been mechanically destroyed or the zero point lies beyond the permissible tolerance range. In this case it will display the *ERROR* message and should be sent to the manufacturer for repair.

Under normal operating conditions, the instrument will display the *O.K.* message after running through the zero-point setting cycle (approx. 1 s).

**Example:**Input:Acknowledgement:*N CR**CRLF O.K. CRLF*

ASCII code:

*4EH 0DH**0DH 0AH 4FH 2EH 4BH 2EH 0DH 0AH*

|                                 |
|---------------------------------|
| R: root-extracted output signal |
|---------------------------------|

The sensor is operating in root-extracted mode, i.e., the output signals will conform to the following mathematical relation:

$$U_{out} = \sqrt{10 \text{ V} * U_{lin}}$$

$$I_{out} = \sqrt{16 \text{ mA} * (I_{lin} - 4 \text{ mA})} + 4 \text{ mA} \quad \text{for } 4...20 \text{ mA}$$

$$I_{out} = \sqrt{20 \text{ mA} * I_{lin}} \quad \text{for } 0...20 \text{ mA}$$

The serial output will conform to the following equation:

$$\text{output value} = \sqrt{1000 * \text{output value}_{in}}$$

After this command is successfully executed, the instrument transmits the *O.K.* message.

This command is not accepted if the sensor is designed for positive and negative measurement ranges (e.g.,  $\pm 100 \text{ Pa}$ ), as root extraction of negative values is not allowed. The instrument returns the *Syntax* message.

**Example:**

Input:

Acknowledgement:

*R CR*

*CRLF SYNTAX CRLF*

ASCII code:

*52H 0DH*

*0DH 0AH 53H 59H 4EH 54H 41H 58H 0DH 0AH*

S: sets the zero-point correction cycle

This command authorizes the zero-point correction cycle (default setting after the instrument is switched on).

Input:

Acknowledgement:

*S CR*

*CRLF O.K. CRLF*

ASCII code:

*53H 0DH*

*0DH 0AH 4FH 2EH 4BH 2EH 0DH 0AH*

|                               |
|-------------------------------|
| Z: time constant, attenuation |
|-------------------------------|

This command sets the sensor attenuation (time constant =  $T_{63}$ ).

This command requires an additional parameter following the Z command letter. Possible time constants are given in the following table:

Z 1: no time constant

Z 2: 1 second

Z 3: 5 seconds

Z 4: 10 seconds

Z 5: 20 seconds

If the P92 receives a value  $X$  that differs from the permitted values (1...5), it will return the *SYNTAX* error message. Otherwise it will display the *O.K.* message.

**Example:**

Input:

Acknowledgement:

Z 8 CR

CRLF SYNTAX CRLF

ASCII code:

5AH 38H 0DH

0DH 0AH 53H 59H 4EH 54H 41H 58H 0DH 0AH

## 9 Design of the Profibus DP (optional)

### 9.1 Features

Once the supply voltage has been connected, the instrument automatically calibrates the zero point, a process which it then repeats on a cyclical basis. The PROFIBUS DP parameters can be used to set the intervals at which the zero-point calibration is performed.

It takes at least 1 s for the instrument to run through this cycle and set the zero-point, during which time it cannot take any measurements; output consists of the most recently measured value. Automatic zero-point calibration allows the instrument to compensate for temperature drift and positional error of the sensor.

If the pressure applied at one of the inputs is larger than a permissible threshold parameter, a valve cuts off the source of the pressure from the pressure measurement capsule, thereby preventing damage to the latter. The most recently measured value is read out at the sensor output.

Measurement data are made available via the PROFIBUS DP interface.

## 9.2 Connecting the supply voltage and setting the address

The instrument is powered via a 24 V DC / 120 mA connector. The current consumption is approx. 120 mA for 24 VDC.

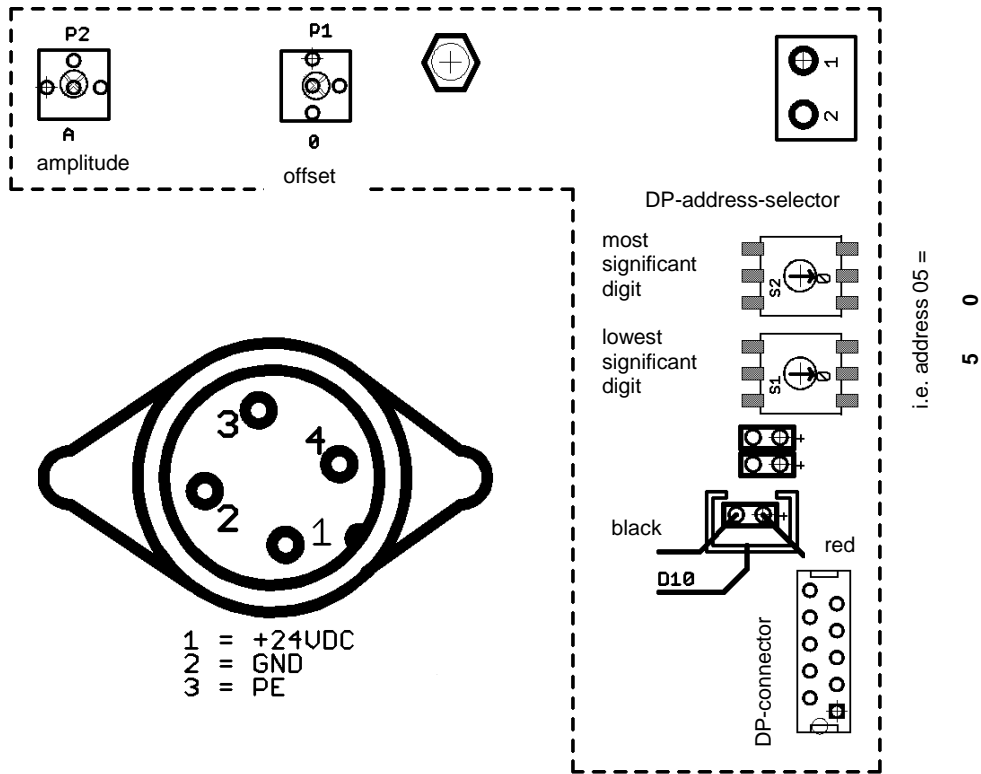

Profibus DP socket (B coding)  
(External top view)

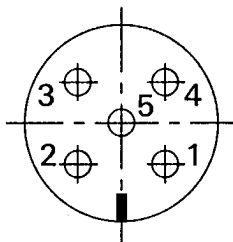

|   |                                  |
|---|----------------------------------|
| 1 | VP +5V                           |
| 2 | RxD/TxD-N / A cable              |
| 3 | DGND (reference potential to VP) |
| 4 | RxD/TxD-P / B cable              |
| 5 | shield                           |

Profibus DP connector (B coding)  
(External top view)

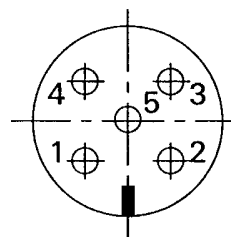

|   |                                  |
|---|----------------------------------|
| 1 | VP +5V                           |
| 2 | RxD/TxD-N / A cable              |
| 3 | DGND (reference potential to VP) |
| 4 | RxD/TxD-P / B cable              |
| 5 | shield                           |

### 9.3 Modules

Several modules are available for Profibus DP communication

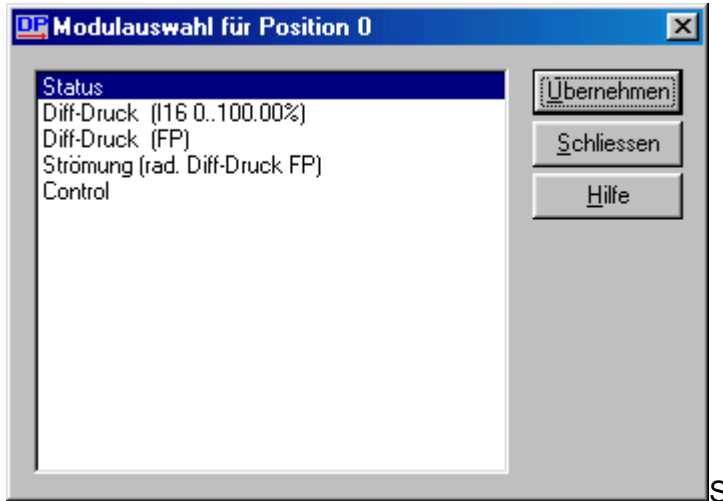

#### 9.3.1 Status

The status module is used for transferring the status of the P92. The following table shows the assignment of the individual bits:

| Bit     | Meaning   |
|---------|---|
| 0 (LSB) | overpressure / vacuum pressure                            |
| 1       | spread active   |
| 2       | zeroing error; zeroing valve could not dissipate pressure |
| 3       | zeroing active  |
| 4       | pressure connected; measurement values valid              |
| 5       | reserved  |
| 6       | reserved  |
| 7 (MSB) | reserved (teach mode active)                              |

#### 9.3.2 Differential pressure (I16 0...100.00%)

This module transmits the differential pressure to the master in the form of a 16-bit integer. Values fall within the range of 0 – 10000 and correspond to the differential pressure in 0 - 100.00%.

#### 9.3.3 Differential pressure (FP)

This reads out the differential pressure as a floating-point value.

### 9.3.4 Flow (root-extracted differential pressure FP)

This reads out the root-extracted value of the differential pressure.

### 9.3.5 Control

During configuration, this module, which acts as the control unit for the P92\_DP differential pressure sensor, must be integrated into data transfer so that pressure can be routed to the valve. The following table lists the corresponding bits and what they mean:

| Bit     | Meaning                        |
|---------|--------------------------------|
| 0 (LSB) | extra; no significance         |
| 1       | extra; no significance         |
| 2       | extra; no significance         |
| 3       | extra; no significance         |
| 4       | extra; no significance         |
| 5       | begin zeroing                  |
| 6       | activate valve, apply pressure |
| 7 (MSB) | extra; no significance         |

## 9.4 Setting parameters

This process allows the user to set a number of pressure sensor parameters.

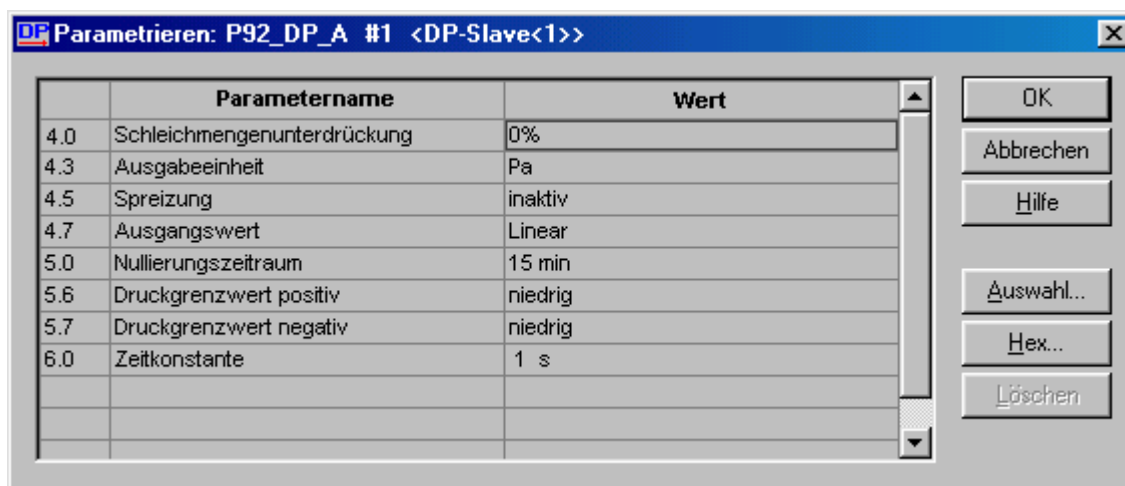

### 9.4.1 Creep suppression

If differential pressure values are less than either the amount of creep or less than 0, the root-extracted value of the differential pressure is set to zero. The user may select values between zero and five percent.

#### **9.4.2 Output units**

This allows the operator to select the units for the floating-point output.

#### **9.4.3 Measurement range spread**

This parameter is used for reducing the measurement range by a factor of 5, thereby increasing the resolution when measured values are small, which can be helpful for root-extracted output. If the measured value is more than twice that of the measurement range spread, the program activates the overpressure valve.

#### **9.4.4 Output value**

This allows the operator to select whether the floating-point value should be read out in terms of pressure or as a percentage.

#### **9.4.5 Zeroing interval**

This allows the user to select the amount of time to elapse between automatic zeroing cycles. Because the instrument warms upon startup, it automatically calibrates the zero point 15 minutes after it is switched on; this eliminates any error introduced by warming.

#### **9.4.6 Positive (negative) threshold pressure**

The user can toggle between two threshold values at which overpressure protection is activated:  $1.4 * P_{nom}$  (low) and  $2 * P_{nom}$  (high).

#### **9.4.7 Time constant**

The instrument includes a digital filter that can be used during pressure regulation to smooth output values, thereby suppressing brief undesired interference. This parameter allows the user to select a time constant for this filter. The larger the time constant, the smoother the measured value and the longer it takes the instrument to achieve a stable measured value. This is not always an advantage when regulating pressure.

## 10 Technical data

|  |   |
|--|---|
| <b>Measurement data</b>  |   |
| measurement ranges   | 0...10 Pa to 0...100 kPa or<br>±10 Pa to ±100 kPa   |
| overload capacity  | when operating: 200x the measurement range limit, max.<br>= 600kPa;<br>under zero-current conditions: all measurement ranges<br>200 kPa   |
| linearity<br>based on a pressure/measurement<br>range of 0... 100% | ± 4 % for measurement ranges between 0...10 and<br>0...50 Pa; ± 1 % for measurement ranges > 50 Pa and <<br>250 Pa<br>± 0,5 % for measurement ranges ≥ 250 Pa<br>(others available upon request)                                      |
| hysteresis   | 0.1 %   |
| time constants   | toggles between 1 s, 2,5 s, 5 s, 10 s,<br>20 s, 40 s (40 s default)<br>selection via Profibus DP (optional)   |
| sensor response time   | 20 ms for measurement ranges ≥ □250 Pa<br>50 ms for measurement ranges < □250 Pa  |
| temperature-dependent drift in zero<br>point                       | 0, if periodic zero-point calibration is active   |
| temperature-dependent drift in<br>measurement range                | 0.03 % / C°   |
| usable measurement range   | linear: -5 % to +130 % of the final value (default)<br>linear: ±130 % of the final value (Profibus)<br>root-extracted: +3 % to +130 % of the final value (default)<br>root-extracted: +3 % to +130 % of the final value<br>(Profibus) |
| max. system pressure   | 10 kPa for measurement ranges ≤10 kPa<br>for measurement ranges greater than 10 kPa → max.<br>nominal pressure of the sensor  |
| <b>Ambient conditions</b>  |   |
| medium   | air, all non-aggressive gases   |
| operating temperature  | 0 °C to +60 °C  |
| storage temperature  | -10 °C to +70 °C  |
| relative humidity  | 0...80 %  |
| EMC standards  | EN 50081 part 1 and EN 50082 part 1; CSA  |
| conformity   |  declaration of conformity available upon request  |
| <b>Electrical data</b>   |   |
| power consumption  | approx. 5 VA (default)<br>approx. 3 VA (Profibus)   |
| supply voltage   | 24 VDC +20% / -15% (with polarity reversal protection)<br>115 VAC +6% / -15% 50 Hz / 60 Hz<br>230 VAC +6% / -15% 50 Hz / 60 Hz<br>(others available upon request)   |
| protection class   | metal housing: IP65<br>plastic housing: IP54  |
| display  | 3½ or 4½-place LCD, character height = 13 mm<br>(optional)  |
|  |   |

|                            |   |
|----------------------------|---|
| connection to power supply | two PG9 threaded connections and screw terminal up to 2.5 mm <sup>2</sup> (default)<br>M18 connector (Profibus)   |
| data interfaces            | 7-pin RS232C socket (optional)<br>9-pin D-sub socket (Profibus optional)  |
|                            |   |
| <b>Physical data</b>       |   |
| pressure port              | Ø 6.5 mm for NW5 tubing<br>(interior tubing diameter = 5 mm)  |
| dimensions (w x h x d)     | metal housing: 122 x 120 x 80 (LCD90)mm<br>plastic housing: 122x120x105 mm  |
| weight                     | plastic housing: 1 kg<br>metal housing: 1.5 kg  |
| options                    | - 3½ or 4½-place LCD<br>- linearity protocol<br>- special design 'high system pressure'<br>- additional control input for initiating zero point correction from an external source (default)<br>- serial RS 232C and RS 485 interfaces (default)<br>- cable gland with two PG7 or two PG11 threaded connections (default) |

#### Appendix A: Parts in contact with measurement medium

- Beryllium bronze CuBe2
- Mu metal (nickel alloy)
- Brass CuZn39Pb3
- Aluminum AlCuMgPb / AlMg3
- Silicon (tubing) optional: Viton
- Crastin (PTBP)
- Araldite CY236 / HY988
- Loctite 242e
- Carbonyl iron
- KEL (FPM: fluorinated rubber)
- Vepuran Vu 4457/51
- UHU-Plus endfest 300 binder

## 11 Dimension drawing

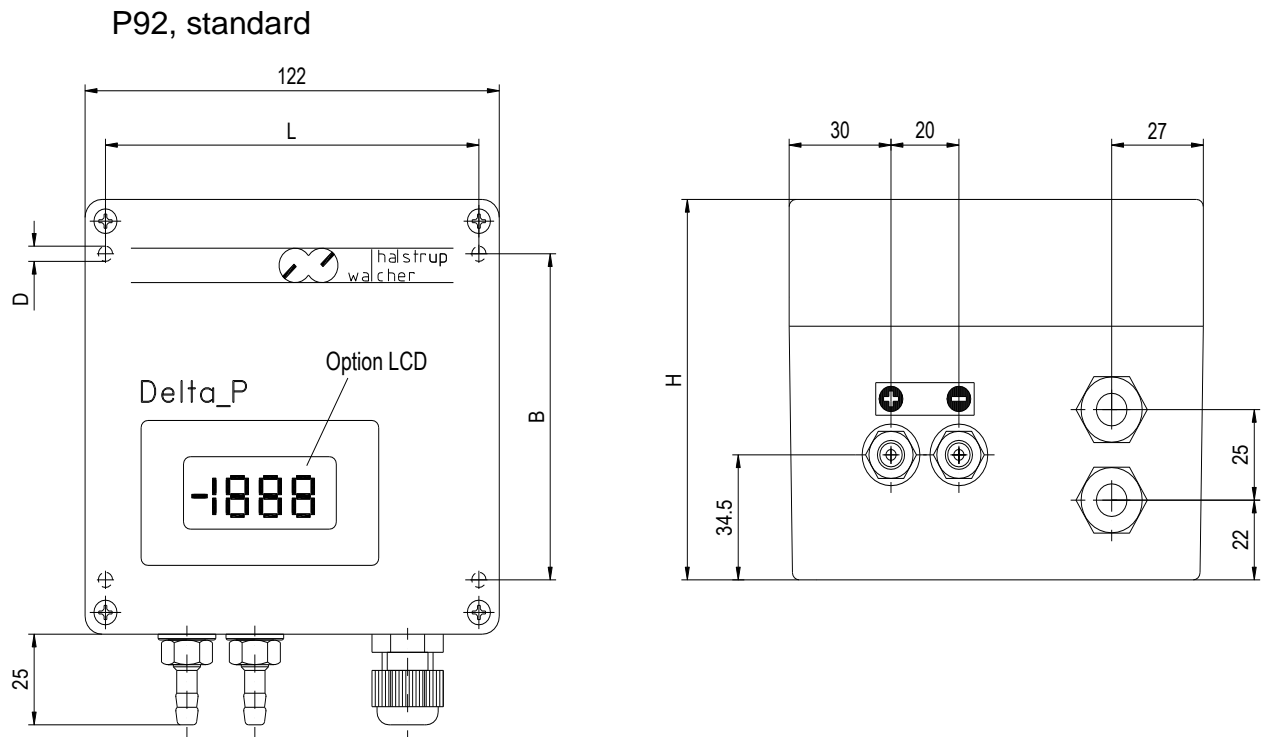

|                        | H   | L   | B    | D   |
|------------------------|-----|-----|------|-----|
| plastic housing        | 105 | 110 | 90.5 | 4.5 |
| plastic housing w/ LCD | 105 | 110 | 90.5 | 4.5 |
| metal housing          | 80  | 106 | 82   | 6.3 |
| metal housing w/ LCD   | 90  | 106 | 82   | 6.3 |

P92-DP

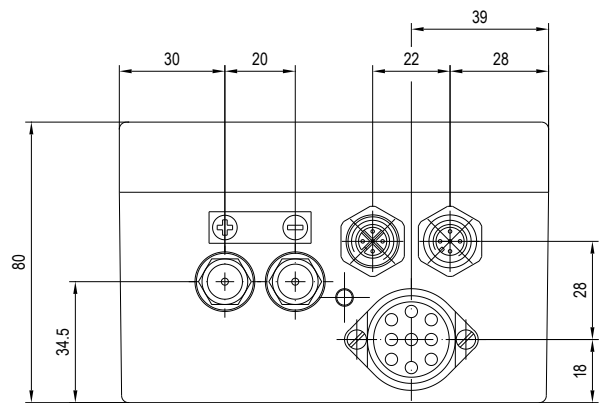
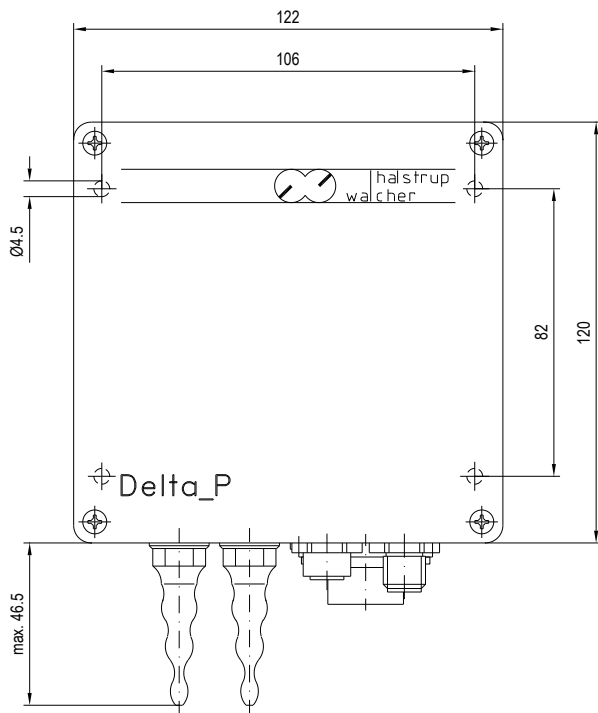

P92-HS

